

Description

The ESD5V02L is a bi-directional TVS diode, utilizing leading monolithic silicon technology to provide fast response time, very low capacitance and low ESD clamping voltage, making this device an ideal solution for protecting voltage sensitive data and power line. The

ESD5V02L complies with the IEC 61000-4-2 (ESD) standard with $\pm 15\text{kV}$ air and $\pm 8\text{kV}$ contact discharge. It is assembled into an ultra-small 1.0x0.6x0.5mm lead-free DFN package. The small size and very low capacitance

make ESD5V02L an ideal choice to protect cell phone, digital cameras, audio players, data interface and many other portable applications.

Features

- Ultra small package: 1.0x0.6x0.5mm
- Ultra low capacitance: 2.5pF typical
- Protects one data or power line
- Working voltage: 5V
- Low clamping voltage
- 2-pin leadless package
- Complies with following standards:
 - IEC 61000-4-2 (ESD) immunity test
 - Air discharge: $\pm 15\text{kV}$
 - Contact discharge: $\pm 8\text{kV}$
 - IEC61000-4-4 (EFT) 40A (5/50ns)
- RoHS Compliant

Mechanical Characteristics

- Package: DFN1006-2 (1.0×0.6×0.5mm)
- Lead Finish: NiPdAu
- Case Material: “Green” Molding Compound.
- UL Flammability Classification Rating 94V-0
- Moisture Sensitivity: Level 3 per J-STD-020
- Terminal Connections: See Diagram Below
- Marking Information: See Below

Applications

- Cellular Handsets and Accessories
- Personal Digital Assistants
- Notebooks and Handhelds
- Portable Instrumentation
- Digital Cameras
- Peripherals
- Audio Players
- Keypads, Side Keys, USB 2.0, LCD Displays

Dimensions & Symbol (Unit: mm Max)

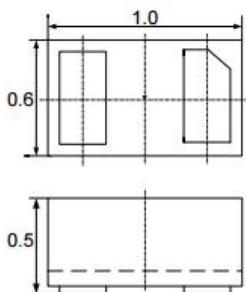

Package Dimensions

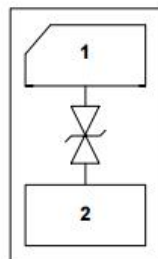

Circuit and Pin Schematic

Ordering Information

Part Number	Packaging	Reel Size
ESD5V02L	5000/Tape & Reel	7 inch

Absolute Maximum Ratings ($T_A=25^\circ\text{C}$, RH=45%-75%, unless otherwise noted)

Parameter	Symbol	Value	Unit
ESD per IEC 61000-4-2 (Air)	VESD	±15	kV
ESD per IEC 61000-4-2 (Contact)		±8	
Peak Pulse Power (tp=1/30ns waveform)	P _{ppp}	80	W
Operating Temperature Range	T _J	-55 to +125	°C
Storage Temperature Range	T _{stg}	-55 to +150	°C

Electrical Characteristics ($T_A=25^\circ\text{C}$)

Parameter	Symbol	Min	Typ	Max	Unit	Test Condition
Reverse Working Voltage	V _{RWM}			5	V	
Breakdown Voltage	V _{BR}	6			V	I _T = 1mA
Reverse Leakage Current	I _R			0.2	μA	V _{RWM} = 5.0V
Clamping Voltage	V _C		9	11	V	I _{PP} = 1A (8 x 20μs pulse)
Junction Capacitance	C _J		2.5	5	pF	V _R = 0V, f = 1MHz

Typical Performance Characteristics (T_A=25°C unless otherwise Specified)

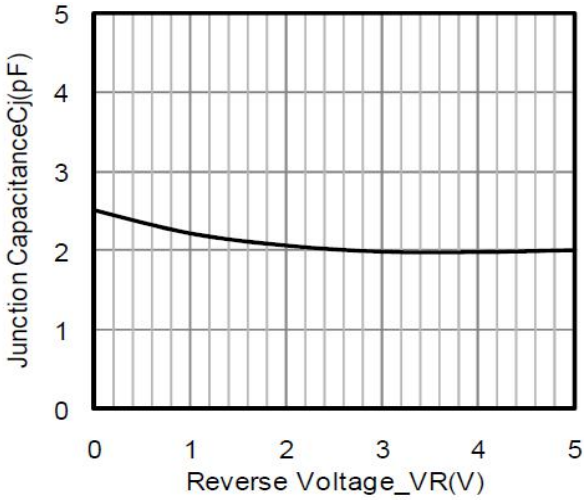

Junction Capacitance vs. Reverse Voltage

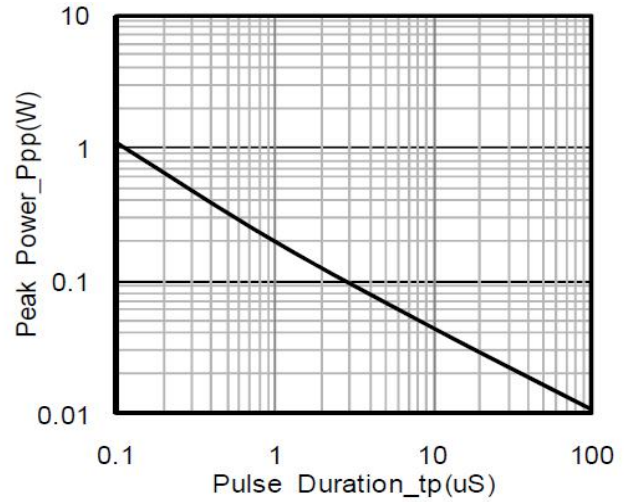

Peak Pulse Power vs. Pulse Time

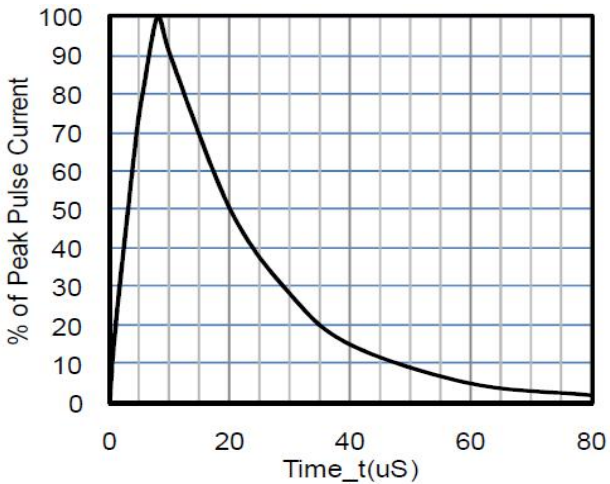

8 X 20uS Pulse Waveform

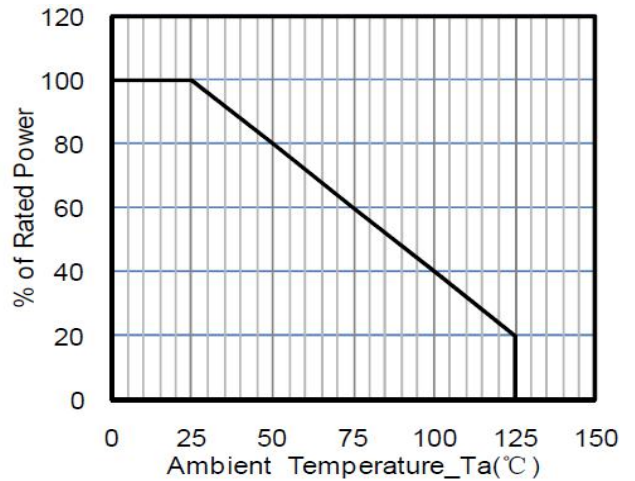

Power Derating Curve

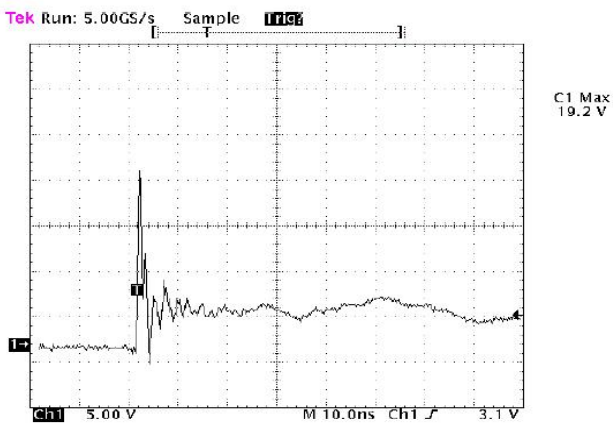

ESD Clamping Voltage

8 kV Contact per IEC61000-4-2

Soldering parameters

Reflow Condition		Pb-Free assembly (see as bellow)
Pre Heat	-Temperature Min ($T_{s(min)}$)	+150°C
	-Temperature Max($T_{s(max)}$)	+200°C
	-Time (Min to Max) (ts)	60-180 secs.
Average ramp up rate (Liquid us Temp (T_L) to peak)		3°C/sec. Max
$T_{s(max)}$ to T_L - Ramp-up Rate		3°C/sec. Max
Reflow	-Temperature(T_L) (Liquid us)	+217°C
	-Temperature(t_L)	60-150 secs.
Peak Temp (T_p)		+260(+0/-5)°C
Time within 5°C of actual Peak Temp (t_p)		30 secs. Max
Ramp-down Rate		6°C/sec. Max
Time 25°C to Peak Temp (T_p)		8 min. Max
Do not exceed		+260°C

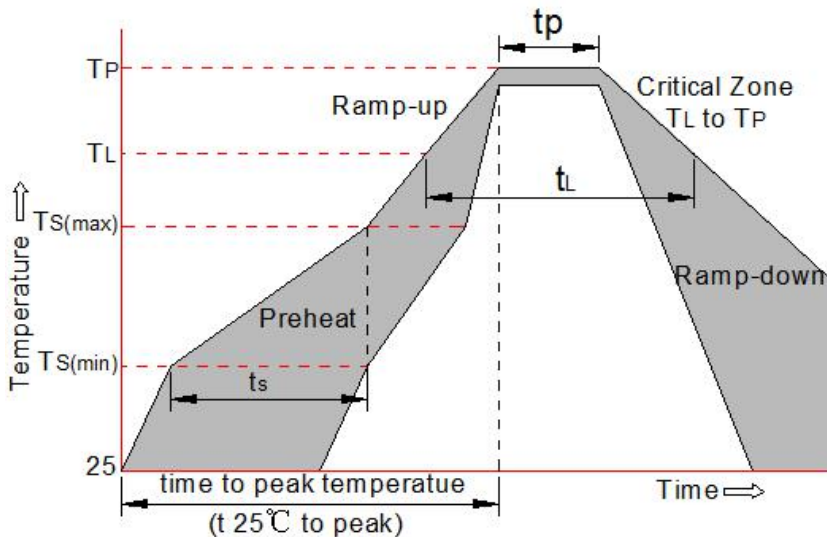

Package mechanical data

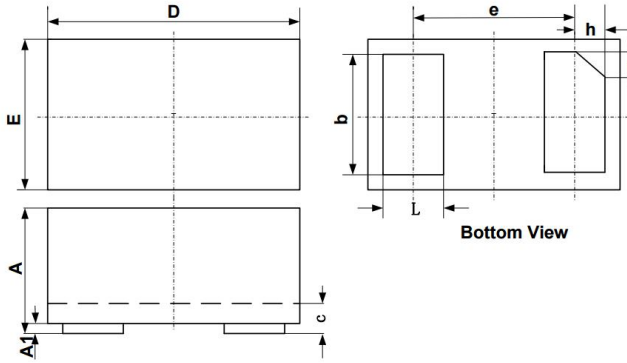

SYM	DIMENSIONS					
	MILLIMETERS			INCHES		
	MIN	NOM	MAX	MIN	NOM	MAX
A	0.45	0.50	0.55	0.018	0.020	0.022
A1	0.00	0.02	0.05	0.000	0.001	0.002
b	0.45	0.50	0.55	0.018	0.020	0.022
c	0.12	0.15	0.18	0.005	0.006	0.007
D	0.95	1.00	1.05	0.037	0.039	0.041
e	0.65 BSC			0.026 BSC		
E	0.55	0.60	0.65	0.022	0.024	0.026
L	0.20	0.25	0.30	0.008	0.010	0.012
h	0.07	0.12	0.17	0.003	0.005	0.007

Suggested Land Pattern

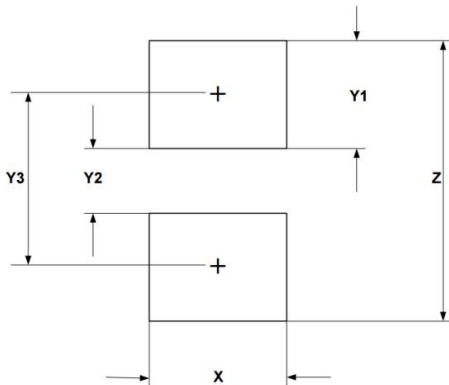

SYM	DIMENSIONS	
	MILLIMETERS	INCHES
X	0.60	0.024
Y1	0.50	0.020
Y2	0.30	0.012
Y3	0.80	0.032
Z	1.30	0.052